

# Monia 037





DESIGN REGUITTI LAB

OTTONE - BRASS



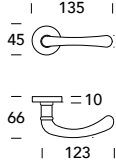
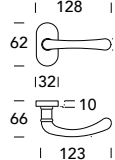
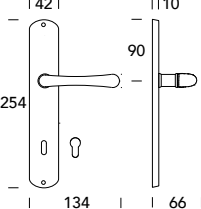
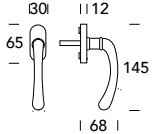

- 
**02**  
 Lucido verniciato  
*Polished varnished*
- 
**08**  
 Bronzato graffiato  
*Brushed bronzed*
- 
**15**  
 Satinato cromato  
*Satin chrome*

COLLEZIONE - COLLECTION

			
<b>037MR416</b>	<b>037MR916</b>	<b>037MP188</b>	<b>037DK024</b>
			

	
<b>037DK075</b>	<b>037MA189</b>
	

BOCCHETTE - ESCUTCHEONS

		
<b>003KN - 003KY</b>	<b>009KN - 009KY</b>	<b>503NO416</b>
