



SERIE 1600

SERRATURE DOPPIA MAPPA PER SERRANDE

Double bitted locks
for rolling shutters

Serrures double panneton
pour rideaux métalliques

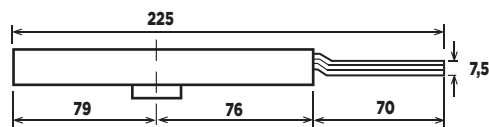
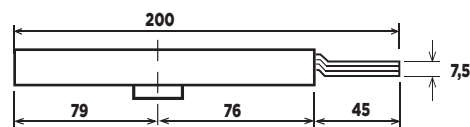
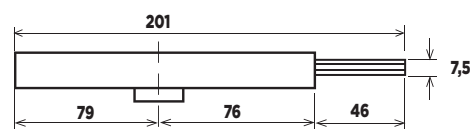
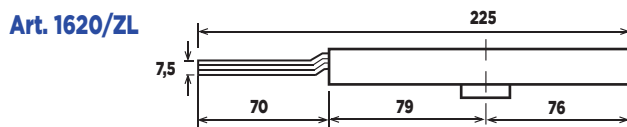
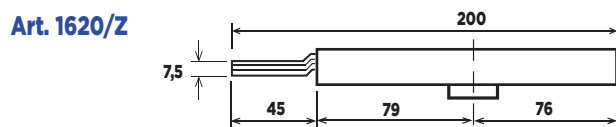
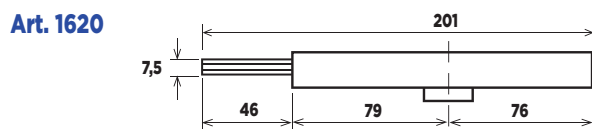
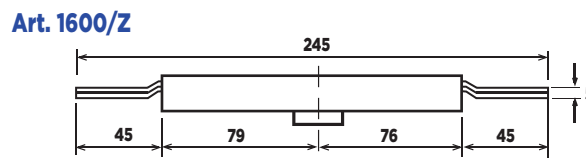
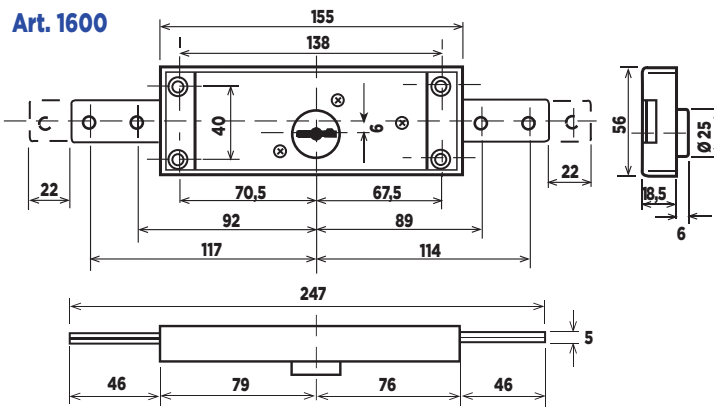
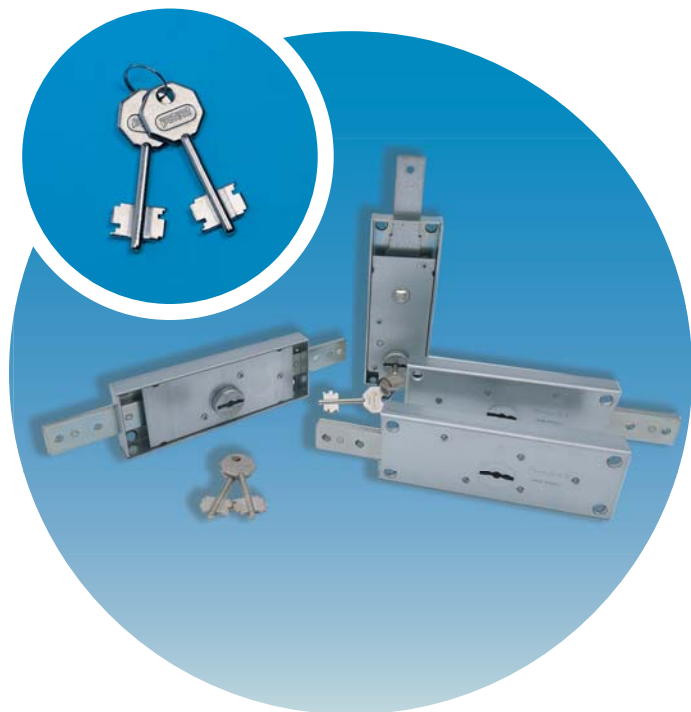

- Serrature doppia mappa a 2 mandate a 1-2-3 punti di chiusura, con 6 gorges
- 6 leve asimmetriche con richiamo a molle (50.000 combinazioni)
- Versioni a catenacci dritti, piegati, allungati con foro aggancio aste 6mm
- Scatola e componenti zincati antiruggine
- Fornite con 2 chiavi cromate senza aste
- Boccola guida chiave esterna integrata
- Sistemi chiave eguale (KA) disponibili a richiesta

- 2-turn double-bitted locks with 1-2-3 locking points, with 6 gorges
- 6 asymmetrical levers with springs recover (50,000 combination codes)
- Straight, shifted, lengthened bolt versions with holes 6mm for bars
 - Rustproof zinc-plated box and components
- Supplied with 2 chromed keys, without bars
 - Integrated external key lead
- Key alike systems (KA) available on demand

- Serrures double panneton 2 tours à 1-2-3 points de fermeture, avec 6 gorges
- 6 gorges asymétriques avec ressorts à rappel (50.000 combinaisons)
- Versions à pènes droits, coudés, allongés avec trou 6mm pour les barres
 - Boîtier et composants zingués antirouille
- Fournies avec 2 clés chromées, sans barres
 - Guide-clé extérieure intégrée
- Systèmes même clé (KA) disponibles sur demande



SERIE 1600

SERRATURE DOPPIA MAPPA PER SERRANDE

Double bitted locks
for rolling shutters

Serrures double panneton
pour rideaux metalliques

- Versioni con catenacci dritti
- Mod. 1625 con tre chiavi per ogni coppia
- Mod. 1600 con perni non ribattuto

- Straight bolt versions
- Mod. 1625 with 3 keys each pair
- Mod. 1600 with pins not rivetted

- Versions avec pènes droites
- Mod. 1625 avec 3 clés par couple
- Mod. avec pènes non rivetés



1600

2

3,90

6

1600.SB

2

0,65

1



1610

1 destro - 1 left - 1 droite

3,60

6

1610.SB

0,60

1



1620

1 sinistro - 1 left - 1 gauche

3,60

6

1620.SB

0,60

1



1630

3

2,10

3

Serrature accoppiate 3 chiavi
Couple of locks with 3 keys
Couples des serrures avec 3 clés



1625

1+1

3,60

3

1625.SB

1+1

1,20

1

SB = Scatola singola - Single Box - Boîte simple