



1 **Informazioni**

2 **Transit**

3 **Transit estensibile**

4 **Transit estensibile per guarnizione in battuta**

5 **Transit Termo**

6 **Accessori generali per soglia transit**

7 **Scontri per soglia Transit**

8 **Indice articoli**

**Nº**

Codice articolo



Confezione unitaria

€
(/00 = 100 pz.)Prezzo lordo in € per singolo pezzo oppure, se
seguito da /00 per 100 pezzi

Altezza soglia



Larghezza soglia

L

Lunghezza



Diametro



1 Informazioni

1.1	Composizione soglia Transit _____	4
1.2	Composizione soglia Transit estensibile _____	5
1.3	Composizione profilato spessoramento Transit estensibile _____	6
1.4	Composizione soglia Transit con guarnizione in battuta H = 34 mm _____	7
1.5	Composizione soglia Transit con guarnizione in battuta per porte d'ingresso H = 24 mm _____	8
1.6	Composizione soglia Transit Termo _____	9
1.7	Composizione profilato spessoramento Transit Termo _____	10

1 Informazioni

1.1 Composizione soglia Transit

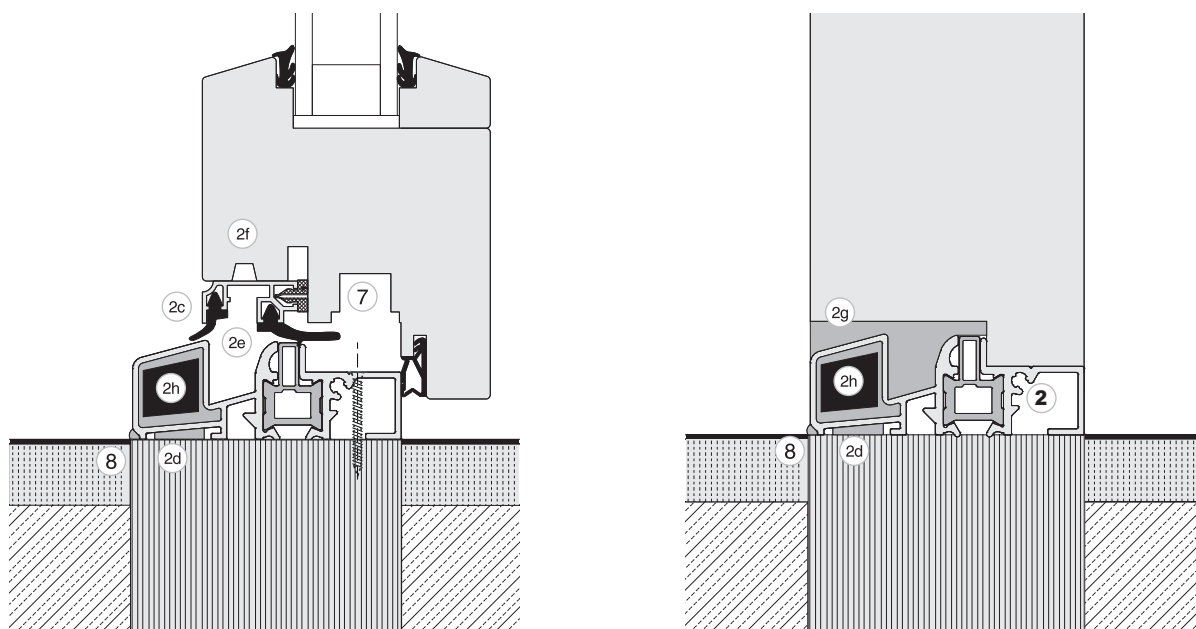

Con taglio termico		Pagina
2	2.1.1 Soglia Transit 68 mm con taglio termico	→11
2a	2.1.2 Soglia Transit 58 mm con taglio termico	→11
2b	2.1.4 Soglia Transit 74 mm con taglio termico per scostamento 13 mm	→12
2c	2.2.1 Guarnizione anta a labbro Transit	→13
2d	2.2.2 Nastro illrid	→13
2e	2.3.1 Distanziatore per guarnizione a labbro Transit	→14
2f	2.3.2 Vite truciolare per guarnizione a labbro Transit	→14
2g	2.3.3 Tappo di testa per soglia Transit	→14
2h	2.3.4 Tappi laterali di chiusura per soglia Transit	→14
7	7.1 Scontri per soglia Transit	→22
8	Silicone	

1.2 Composizione soglia Transit estensibile

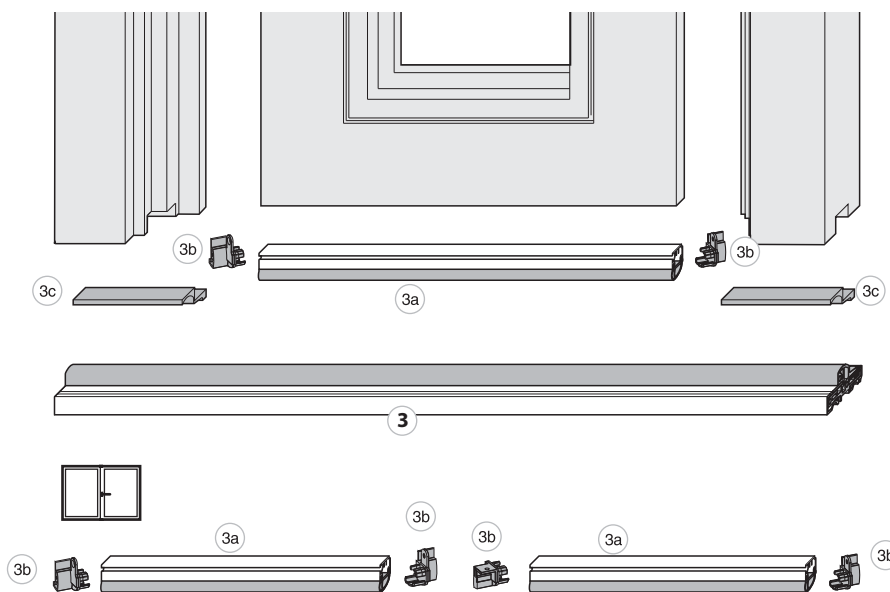
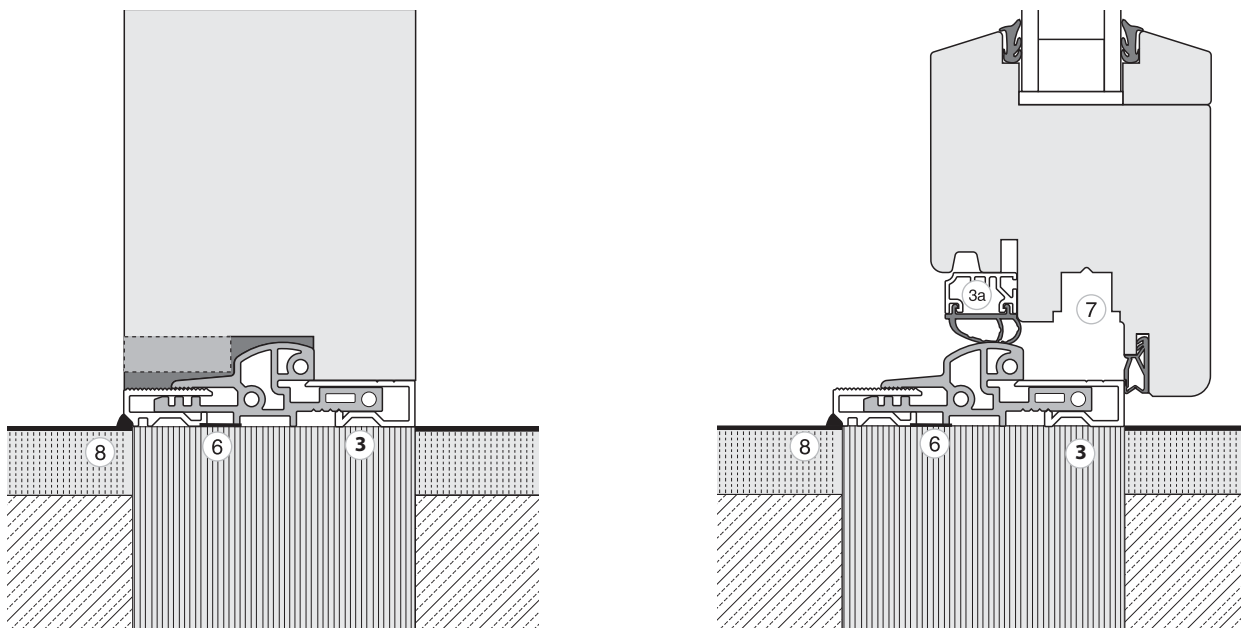

Componenti soglia		Pagina
3	3.1 Soglia Transit estensibile	→ 15
3a	3.2 Guarnizioni per soglia Transit estensibile	→ 15
3b	3.3 Confezioni terminali per soglia Transit estensibile	→ 16
3c	3.4 Tappo di testa per soglia Transit estensibile	→ 16
6	6.4 Illbruck Nastro Butilico	→ 20
7	7.1 Scontri per soglia Transit	→ 22
8	Silicone	

1.3 Composizione profilato spessoramento Transit estensibile

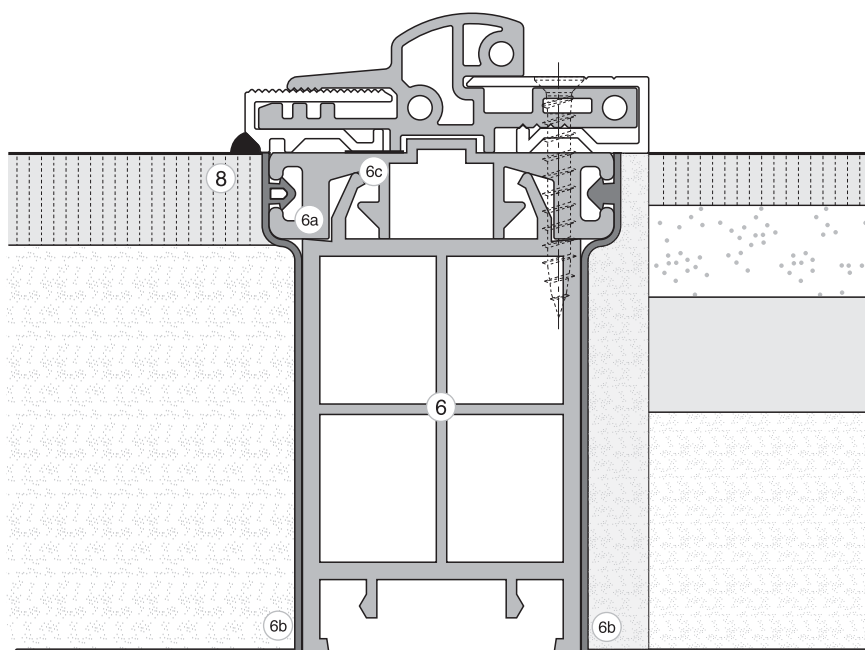

Componenti soglia		Pagina
6	6.1 Profilo di spessoramento per soglia TRANSIT	→20
6a	6.2 Adattatore per profilo spessoramento	→20
6b	6.3 Membrana impermeabilizzante su soglia	→20
6c	6.4 Illbruck Nastro Butilico	→20
8	Silicone	

1.4 Composizione soglia Transit con guarnizione in battuta H = 34 mm

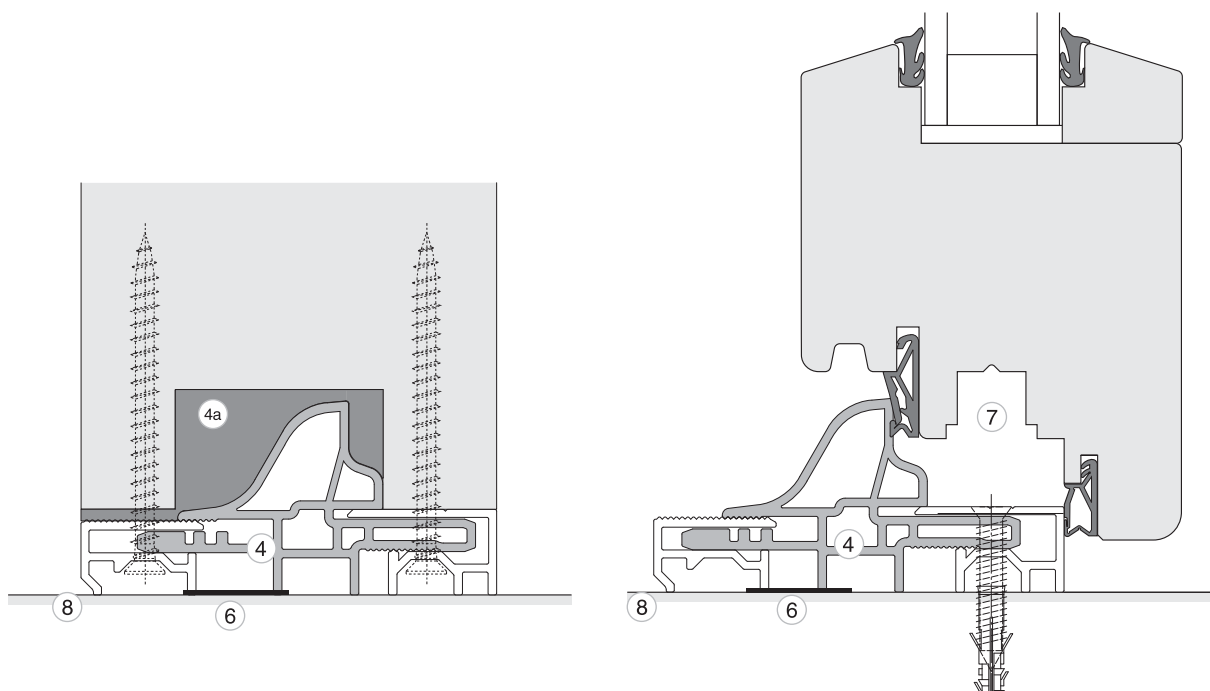

Componenti soglia		Pagina
④	4.1 Soglia Transit estensibile per guarnizione in battuta	→18
④a	4.3 Tappo di testa per soglia Transit estensibile per guarnizione in battuta	→18
⑥	6.4 Illbruck Nastro Butilico	→20
⑦	7.1 Scontri per soglia Transit	→22
⑧	Silicone	

1.5 Composizione soglia Transit con guarnizione in battuta per porte d'ingresso H = 24 mm

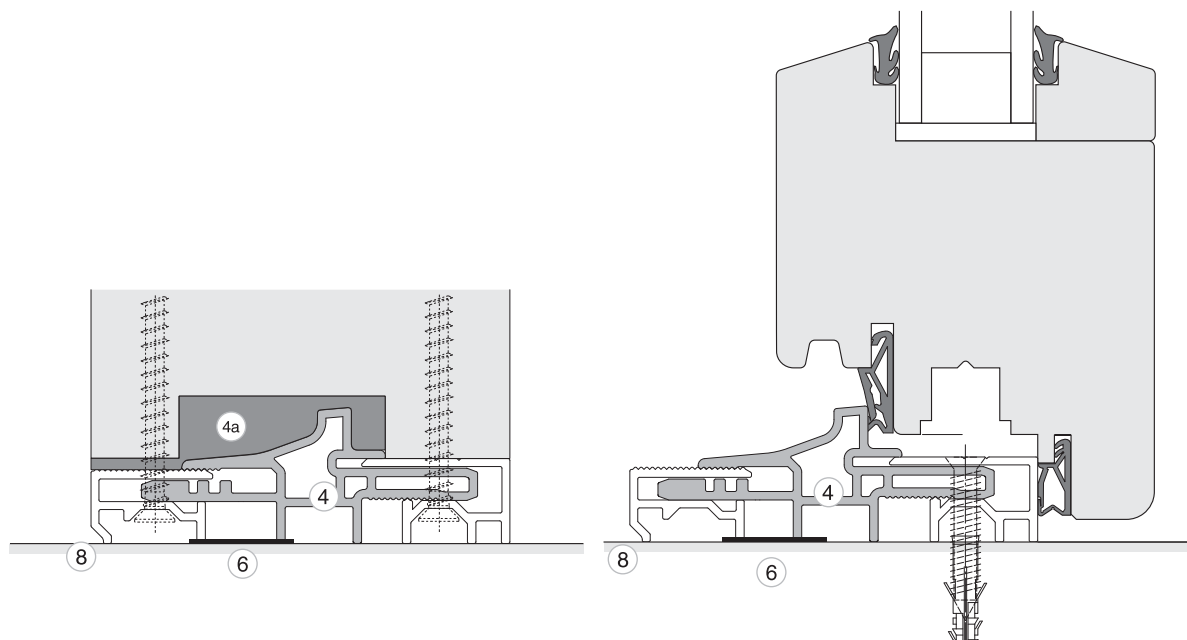

Componenti soglia		Pagina
④	4.2 Soglia Transit estensibile per guarnizione in battuta porta d'ingresso	→ 18
④a	4.3 Tappo di testa per soglia Transit estensibile per guarnizione in battuta	→ 18
⑥	6.4 Illbruck Nastro Butilico	→ 20
⑧	Silicone	

1.6 Composizione soglia Transit Termo

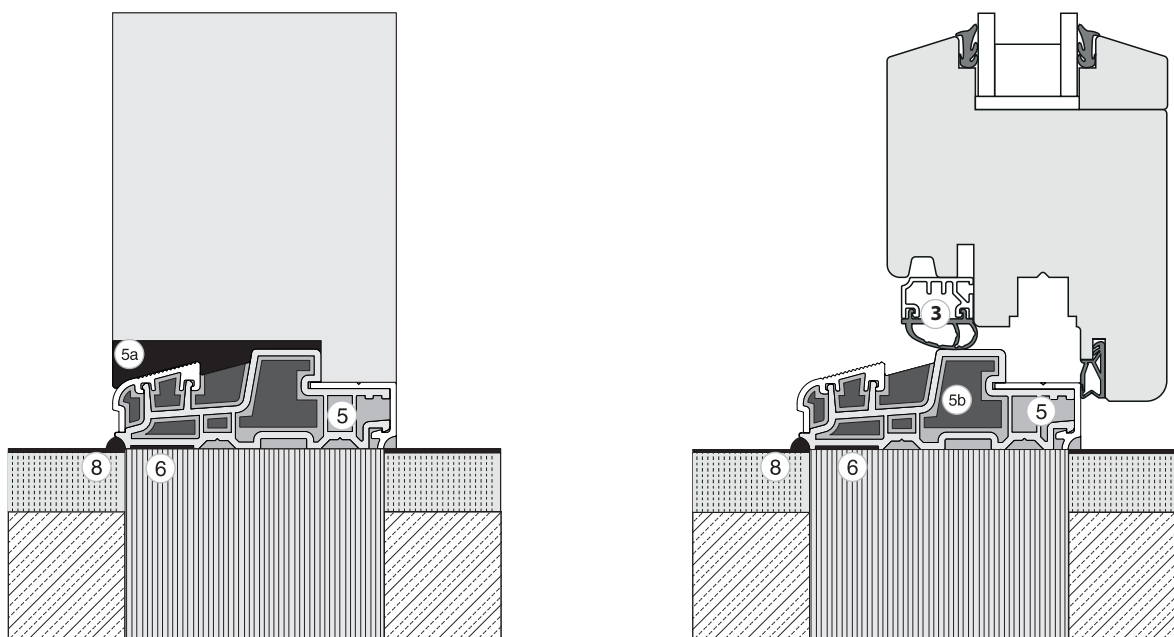

Componenti soglia		Pagina
3	3.2 Guarnizioni per soglia Transit estensibile	→ 15
5	5.1 Soglia Transit Termo	→ 19
5a	5.2.1 Tappo di testa per soglia Transit Termo	→ 19
5b	5.2.2 Tappi laterali per soglia Transit Termo	→ 19
6	6.4 Illbruck Nastro Butilico	→ 20
8	Silicone	

1.7 Composizione profilato spessoramento Transit Termo

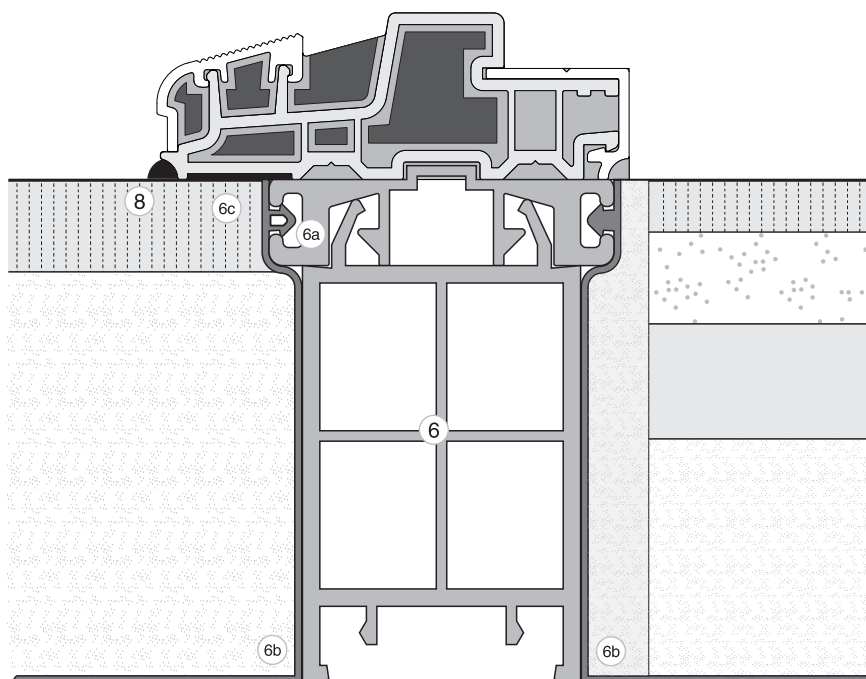

Componenti soglia		Pagina
6	6.1 Profilo di spessoramento per soglia TRANSIT	→20
6a	6.2 Adattatore per profilo spessoramento	→20
6b	6.3 Membrana impermeabilizzante su soglia	→20
6c	6.4 Illbruck Nastro Butilico	→20
8	Silicone	

2 Transit

2.1 Soglie Transit

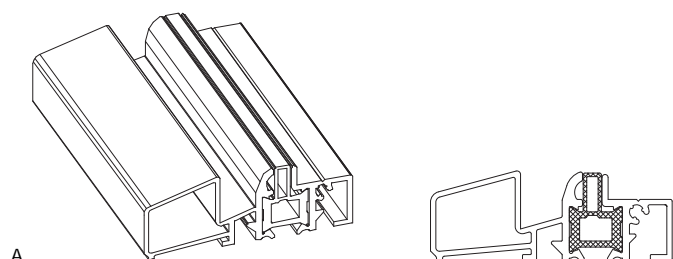

2.1.1 Soglia Transit 68 mm con taglio termico

	L	↳	↳	↳	A	No
F1	5000	68	1		A	N625000
F3/4	5000	68	1			N525000

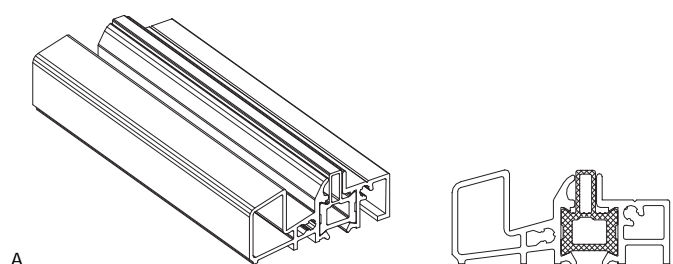

2.1.2 Soglia Transit 58 mm con taglio termico

	L	↳	↳	↳	A	No
F1	5000	58	1		A	N625001
F3/4	5000	58	1			N525001

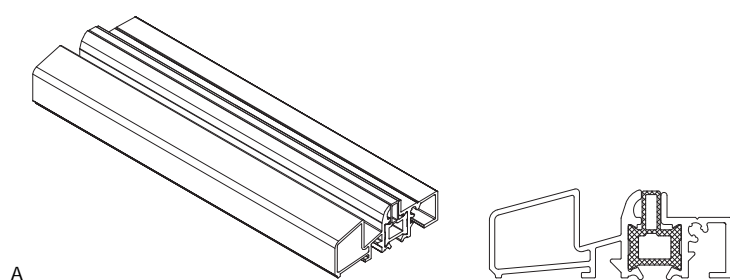

2.1.3 Soglia Transit 68 mm con taglio termico per scostamento 13 mm

	L	↳	↳	↳	A	No
F1	5000	68	1		A	456754
F3/4	5000	68	1			456758

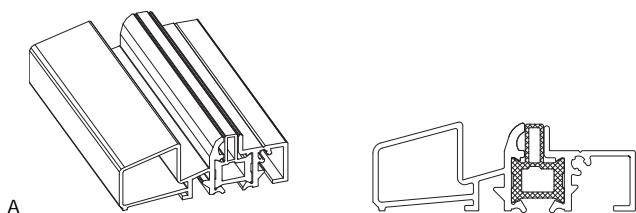

2.1.4 Soglia Transit 74 mm con taglio termico per scostamento 13 mm



Nº

F1	5000	74	1	A	454090
F3/4	5000	74	1		454091

2.2 Guarnizioni Transit

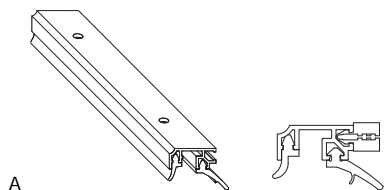

A

2.2.1 Guarnizione anta a labbro Transit

		L				No
F1	AB 10	2500	10		A	N103001
	AB 12	2500	10			N123001
F3/4	AB 10	2500	10			N103000
	AB 12	2500	10			N123000

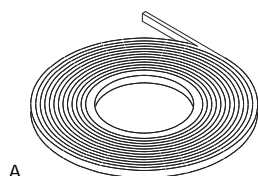

A

2.2.2 Nastro illrid

		L				No
antracite	10/5	12	1			454164
		540	540		A	L992228
	10/6	450	450			454037*
	10/8	7,5	1			457852
	15/3	600	600			457911*

2.3 Accessori Transit

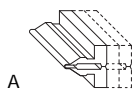

A

2.3.1 Distanziatore per guarnizione a labbro Transit



No

Distanziatore 2/4/6mm per guarnizione a labbro transit

100

A

N300000

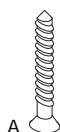

A

2.3.2 Vite truciolare per guarnizione a labbro Transit



No

per guarnizione a labbro

2,5

500

A

N400000

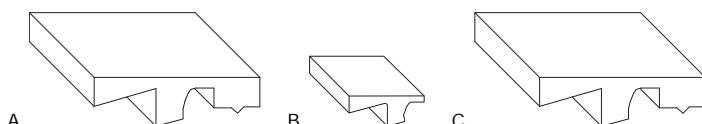

A

B

C

2.3.3 Tappo di testa per soglia Transit



No

S=58 mm

100

A

N520001

S=68 mm tagliato a 50 mm

100

B

N520010

S=68 mm

100

C

N520000

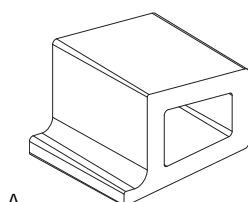

A

2.3.4 Tappi laterali di chiusura per soglia Transit



No

laterali (sx+dx) per soglia Transit 68mm

1

A

N520020

50

N520021



A

2.3.5 Spessore tazza per supporto cerniera ad incasso su soglia Transit



No

A12/AB18 sinistro

100

40751

A12/AB18 destro

100

A

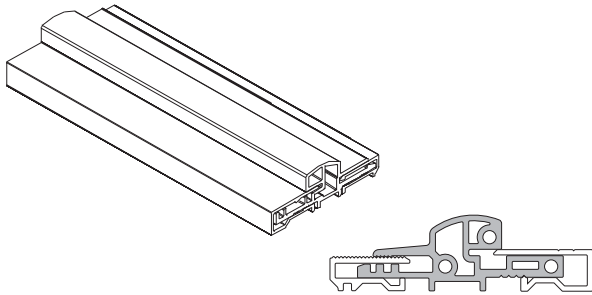

40750

3 Transit estensibile



A

3.1 Soglia Transit estensibile

		L					No
F1	2500	20	58 - 76	1	A	457131	
		24	58 - 76	1	457304		
	3000	24	58 - 76	1	457757		
		5000	20	58 - 76	1	457659	
	24		58 - 76	1	457661		
	20		76 - 94	1	459024		
	24		76 - 94	1	459026		
	20		90 - 108	1	459028		
	24		90 - 108	1	459030		
	F3/4	2500	20	58 - 76	1	457132	
24			58 - 76	1	457305		
3000		24	58 - 76	1	457758		
		5000	20	58 - 76	1	457660	
24			58 - 76	1	457662		
20			76 - 94	1	459025		
24			76 - 94	1	459027		
20			90 - 108	1	459029		
24			90 - 108	1	459031		

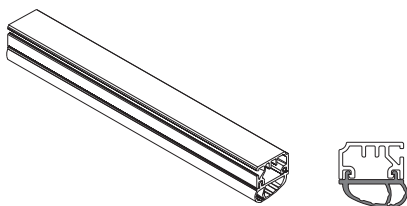

A

3.2 Guarnizioni per soglia Transit estensibile

		L			No
F1	AB 10	2500	10	A	457133
	AB 12	2500	10	457134	
F3/4	AB 10	2500	10	457135	
	AB 12	2500	10	457136	

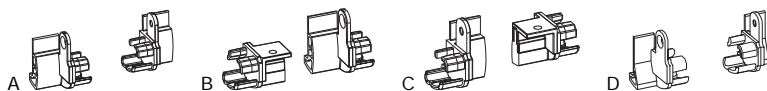

3.3 Confezioni terminali per soglia Transit estensibile				No
per guarnizione anta	grigio RAL 7035	AB 10	20	
	nero	AB 10	20	A 457140
	grigio RAL 7035	AB 12	20	
	nero	AB 12	20	459014
per nodo centrale sinistra	grigio RAL 7035	AB 10	20	
	nero	AB 10	20	B 457139
	grigio RAL 7035	AB 12	20	
	nero	AB 12	20	459020
per nodo centrale destra	grigio RAL 7035	AB 10	20	
	nero	AB 10	20	C 457138
	grigio RAL 7035	AB 12	20	
	nero	AB 12	20	459018
per guarnizione telaio	grigio RAL 7035	AB 10	20	
	nero	AB 10	20	D 457141
	grigio RAL 7035	AB 12	20	
	nero	AB 12	20	459016
				457145

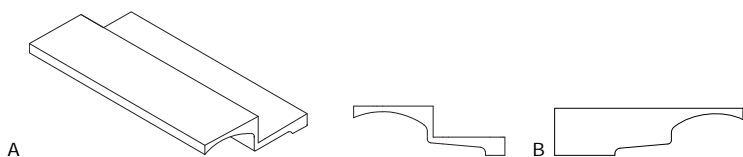

3.4 Tappo di testa per soglia Transit estensibile				No
4,5 mm	S=58-76 mm	50	A	457137
	S=76-108 mm	50		459032
12,5 mm	S=58-76 mm	1	B	457962
	S=76-108 mm			459283

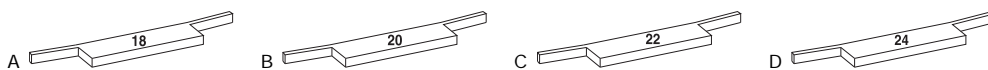

3.5 Spessore soglia Transit estensibile per profondità battuta				No
per battuta 18		100	A	457742
per battuta 20		100	B	457743
per battuta 22		100	C	457744
per battuta 24		100	D	457745

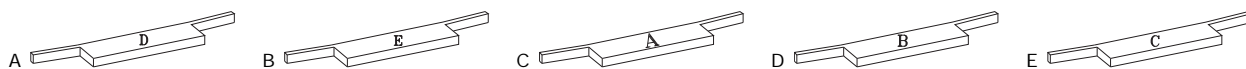

3.6 Spessore soglia Transit estensibile parte esterna

No

parte esterna D L=10,2mm	100	A	457749*
parte esterna E L=12,2mm	100	B	457750*
parte esterna A L=4,2mm	100	C	457746*
parte esterna F L=5,2mm	100		457937*
parte esterna B L=6,2mm	100	D	457747*
parte esterna C L=8,2mm	100	E	457748*

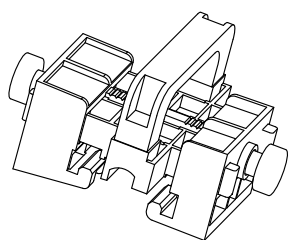

A

3.7 Dima per soglia Transit estensibile

No

dima per soglia transit estensibile

1

A

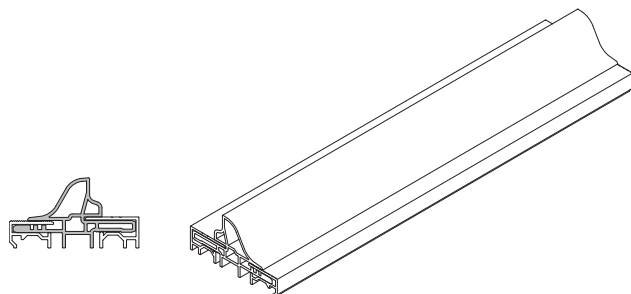

457766

4 Transit estensibile per guarnizione in battuta



A

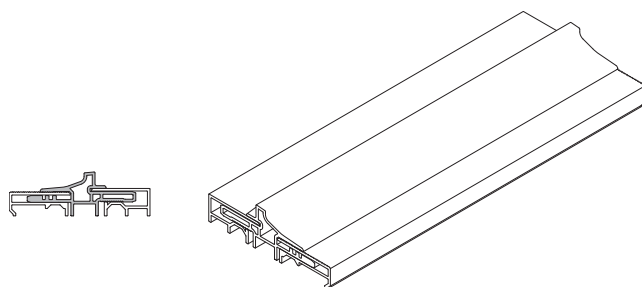

4.1 Soglia Transit estensibile per guarnizione in battuta

	L					No
F1	5000	34	63 - 76	1	A	462248
			77 - 94	1		462249
			91 - 108	1		462250
F3/4	5000	34	63 - 76	1		462380
			77 - 94	1		462381
			91 - 108	1		462382



A

4.2 Soglia Transit estensibile per guarnizione in battuta porta d'ingresso

	L					No
F1	5000	24	63 - 76	1	A	462251
			77 - 94	1		462252
			91 - 108	1		462253
F3/4	5000	34	63 - 76	1		462383
			77 - 94	1		462384
			91 - 108	1		462385

A

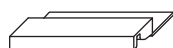

B

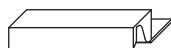

4.3 Tappo di testa per soglia Transit estensibile per guarnizione in battuta

		No
Tappo di testa per soglia Transit estensibile con guarnizione in battuta porta d'ingresso S=74mm dx+sx nero	A	462272
Tappo di testa per soglia Transit estensibile con guarnizione in battuta S=74mm dx+sx nero	B	462271

5 Transit Termo

5.1 Soglia Transit Termo

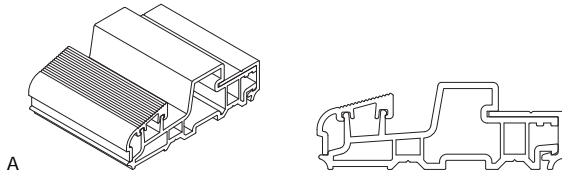

A

5.1.1 Soglia Transit Termo 68 mm

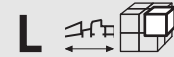

No

F1	5000	68	1	A	460618 ¹
F3/4	5000	68	1		460619 ¹

¹ per scostamento 9 mm e battuta 18 mm

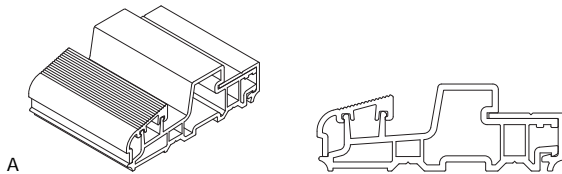

A

5.1.2 Soglia Transit Termo 74 mm



No

F1	5000	74	1	A	460620 ¹
F3/4	5000	74	1		460621 ¹

¹ per scostamento 13 mm e battuta 24 mm

5.2 Accessori per soglia Transit Termo

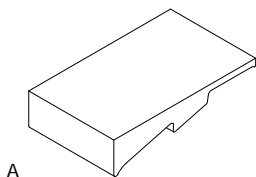

A

5.2.1 Tappo di testa per soglia Transit Termo



No

S=68/74 mm

50

A

460622

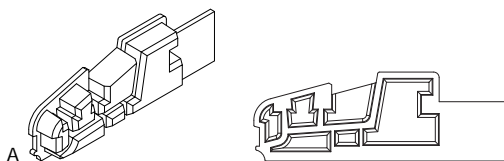

A

5.2.2 Tappi laterali per soglia Transit Termo



No

laterali (sx+dx) per soglia Transit Termo 68 mm	50	A	460623
laterali (sx+dx) per soglia Transit Termo 74 mm	50		460624

6 Accessori generali per soglia transit

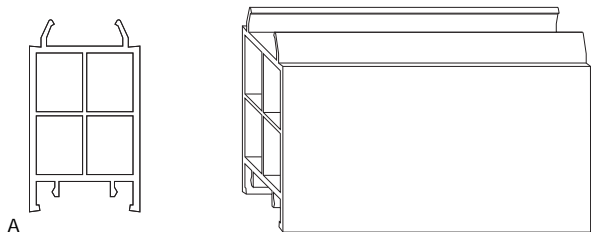

6.1 Profilo di spessoramento per soglia TRANSIT



Nº

6000 68 1 A X106000

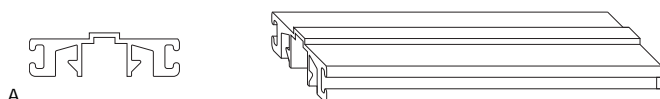

6.2 Adattatore per profilo spessoramento

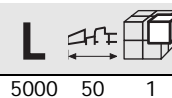

Nº

5000 50 1 A 457481



6.3 Membrana impermeabilizzante su soglia



Nº

Membrana impermeabilizzante S=200 mm 10 m nero

1 A 356640

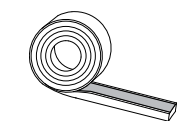

6.4 Illbruck Nastro Butilico



Nº

grigio	10x1,5	550	550	A	460172
	15x1,5	450	450		460173
	20x1,5	350	350		460174



A

6.5 Sigillante Terostat



No

Sigillante Henkel Terostat IX (1kg) L=0m

1

A

X310000

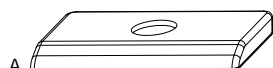

A



B

6.6 Cuneo d'invito



No

Cuneo invito parte anta A12 battuta liscia/20 argento

50

A

44351

Cuneo invito parte telaio A12 battuta liscia/20 argento

50

B

44350

7 Scontri per soglia Transit

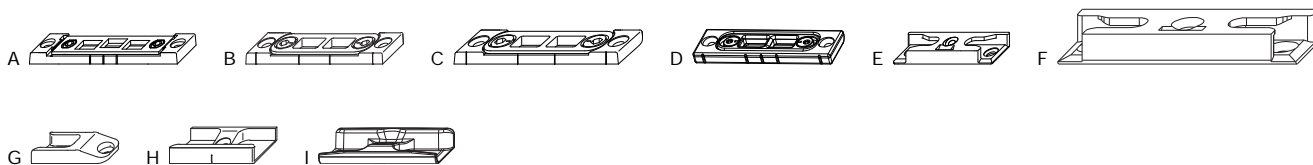

7.1 Scontri per soglia Transit			N°
Scontro catenaccio battuta liscia/18 3 fori rinforzato acciaio argento	100	A	26308
Scontro catenaccio battuta liscia/18 H=6,5 mm 2 fori argento	100	B	23731
Scontro catenaccio battuta liscia/20 2 fori argento	100	C	26241
Scontro catenaccio profondità battuta 24 mm scostamento 13 mm 2 fori argento	100	D	203329
Scontro fungo per soglia battuta liscia/18 con vite inclinata argento	100	E	355606
Scontro fungo per soglia battuta liscia/20 con vite inclinata argento	100	F	96779
Scontro nottolino battuta liscia/18 2 fori vite argento	200	G	34943
Scontro nottolino battuta liscia/20 con vite inclinata argento	200	H	34981
Scontro nottolino profondità battuta 24 mm scostamento 13 mm con vite inclinata argento	200	I	34934

8 Indice articoli

No	Gruppo		€ (/oo = 100 pz.)	Pagina
203329	TOT-A-01-09-04 Scontro catenaccio	100		22
23731	TOT-A-01-09-04 Scontro catenaccio	100		22
26241	TOT-A-01-09-04 Scontro catenaccio	100		22
26308	TOT-A-01-09-04 Scontro catenaccio	100		22
34934	TOT-A-01-09-01 Scontro nottolino	200		22
34943	TOT-A-01-09-01 Scontro nottolino	200		22
34981	TOT-A-01-09-01 Scontro nottolino	200		22
355606	TOT-A-01-09-08 Scontro fungo autoregolante	100		22
356640	TOT-B-02-04-03 Alzanti scorrevoli accessori	1		20
40750	TOT-A-01-11-08 Spessori in PVC	100		14
40751	TOT-A-01-11-08 Spessori in PVC	100		14
44350	TOT-A-01-11-08 Spessori in PVC	50		21
44351	TOT-A-01-11-08 Spessori in PVC	50		21
454037	TOT-Y-03-01 Nastri precompressi	450		13
454090	TOT-M-01-01-02-01 Transit soglie 68 mm TT	1		12
454091	TOT-M-01-01-02-01 Transit soglie 68 mm TT	1		12
454164	TOT-Y-03-01 Nastri precompressi	1		13
456754	TOT-M-01-01-02-01 Transit soglie 68 mm TT	1		11
456758	TOT-M-01-01-02-01 Transit soglie 68 mm TT	1		11
457131	TOT-M-04-01 Transit estensibile soglie	1		15
457132	TOT-M-04-01 Transit estensibile soglie	1		15
457133	TOT-M-04-02-01 Transit estensibile guarnizioni AB10	10		15
457134	TOT-M-04-02-02 Transit estensibile guarnizioni AB12	10		15
457135	TOT-M-04-02-01 Transit estensibile guarnizioni AB10	10		15
457136	TOT-M-04-02-02 Transit estensibile guarnizioni AB12	10		15
457137	TOT-M-04-03-01 Transit estensibile accessori tappi	50		16
457138	TOT-M-04-03-02 Transit estensibile accessori terminali	20		16
457139	TOT-M-04-03-02 Transit estensibile accessori terminali	20		16
457140	TOT-M-04-03-02 Transit estensibile accessori terminali	20		16
457141	TOT-M-04-03-02 Transit estensibile accessori terminali	20		16
457142	TOT-M-04-03-02 Transit estensibile accessori terminali	20		16
457143	TOT-M-04-03-02 Transit estensibile accessori terminali	20		16
457144	TOT-M-04-03-02 Transit estensibile accessori terminali	20		16
457145	TOT-M-04-03-02 Transit estensibile accessori terminali	20		16
457304	TOT-M-04-01 Transit estensibile soglie	1		15
457305	TOT-M-04-01 Transit estensibile soglie	1		15
457481	TOT-M-01-03-02 Transit accessori	1		20
457659	TOT-M-04-01 Transit estensibile soglie	1		15
457660	TOT-M-04-01 Transit estensibile soglie	1		15
457661	TOT-M-04-01 Transit estensibile soglie	1		15
457662	TOT-M-04-01 Transit estensibile soglie	1		15
457742	TOT-M-01-03-02 Transit accessori	100		16
457743	TOT-M-01-03-02 Transit accessori	100		16
457744	TOT-M-01-03-02 Transit accessori	100		16
457745	TOT-M-01-03-02 Transit accessori	100		16
457746	TOT-M-01-03-02 Transit accessori	100		17
457747	TOT-M-01-03-02 Transit accessori	100		17
457748	TOT-M-01-03-02 Transit accessori	100		17
457749	TOT-M-01-03-02 Transit accessori	100		17
457750	TOT-M-01-03-02 Transit accessori	100		17
457757	TOT-M-04-01 Transit estensibile soglie	1		15
457758	TOT-M-04-01 Transit estensibile soglie	1		15
457766	TOT-S-01 Dime	1		17
457852	TOT-Y-03-01 Nastri precompressi	1		13
457911	TOT-Y-03-01 Nastri precompressi	600		13
457937	TOT-M-01-03-02 Transit accessori	100		17
457962	TOT-M-04-03-01 Transit estensibile accessori tappi	1		16
459013	TOT-M-04-03-02 Transit estensibile accessori terminali	20		16
459014	TOT-M-04-03-02 Transit estensibile accessori terminali	20		16
459015	TOT-M-04-03-02 Transit estensibile accessori terminali	20		16
459016	TOT-M-04-03-02 Transit estensibile accessori terminali	20		16
459017	TOT-M-04-03-02 Transit estensibile accessori terminali	20		16
459018	TOT-M-04-03-02 Transit estensibile accessori terminali	20		16
459019	TOT-M-04-03-02 Transit estensibile accessori terminali	20		16
459020	TOT-M-04-03-02 Transit estensibile accessori terminali	20		16
459024	TOT-M-04-01 Transit estensibile soglie	1		15
459025	TOT-M-04-01 Transit estensibile soglie	1		15
459026	TOT-M-04-01 Transit estensibile soglie	1		15
459027	TOT-M-04-01 Transit estensibile soglie	1		15

N°	Gruppo		€ (/oo = 100 pz.)	Pagina
459028	TOT-M-04-01 Transit estensibile soglie	1		15
459029	TOT-M-04-01 Transit estensibile soglie	1		15
459030	TOT-M-04-01 Transit estensibile soglie	1		15
459031	TOT-M-04-01 Transit estensibile soglie	1		15
459032	TOT-M-04-03-01 Transit estensibile accessori tappi	50		16
459283	TOT-M-04-03-01 Transit estensibile accessori tappi			16
460172	TOT-Y-03-03 Sigillanti e collanti	550		20
460173	TOT-Y-03-03 Sigillanti e collanti	450		20
460174	TOT-Y-03-03 Sigillanti e collanti	350		20
460618	TOT-M-01-01-02-01 Transit soglie 68 mm TT	1		19
460619	TOT-M-01-01-02-01 Transit soglie 68 mm TT	1		19
460620	TOT-M-01-01-02-01 Transit soglie 68 mm TT	1		19
460621	TOT-M-01-01-02-01 Transit soglie 68 mm TT	1		19
460622	TOT-M-01-03-01 Transit accessori tappi di testa	50		19
460623	TOT-M-01-03-01 Transit accessori tappi di testa	50		19
460624	TOT-M-01-03-01 Transit accessori tappi di testa	50		19
462248	TOT-M-04-01 Transit estensibile soglie	1		18
462249	TOT-M-04-01 Transit estensibile soglie	1		18
462250	TOT-M-04-01 Transit estensibile soglie	1		18
462251	TOT-M-04-01 Transit estensibile soglie	1		18
462252	TOT-M-04-01 Transit estensibile soglie	1		18
462253	TOT-M-04-01 Transit estensibile soglie	1		18
462271	TOT-M-04-03-01 Transit estensibile accessori tappi			18
462272	TOT-M-04-03-01 Transit estensibile accessori tappi			18
462380	TOT-M-04-01 Transit estensibile soglie	1		18
462381	TOT-M-04-01 Transit estensibile soglie	1		18
462382	TOT-M-04-01 Transit estensibile soglie	1		18
462383	TOT-M-04-01 Transit estensibile soglie	1		18
462384	TOT-M-04-01 Transit estensibile soglie	1		18
462385	TOT-M-04-01 Transit estensibile soglie	1		18
96779	TOT-A-01-09-08 Scontro fungo autoregolante	100		22
L				
L992228	TOT-Y-03-01 Nastri precompressi	540		13
N				
N103000	TOT-M-01-02-01 Transit guarnizioni a labbro 10 mm	10		13
N103001	TOT-M-01-02-01 Transit guarnizioni a labbro 10 mm	10		13
N123000	TOT-M-01-02-02 Transit guarnizioni a labbro 12 mm	10		13
N123001	TOT-M-01-02-02 Transit guarnizioni a labbro 12 mm	10		13
N300000	TOT-M-01-03-02 Transit accessori	100		14
N400000	TOT-M-01-03-02 Transit accessori	500		14
N520000	TOT-M-01-03-01 Transit accessori tappi di testa	100		14
N520001	TOT-M-01-03-01 Transit accessori tappi di testa	100		14
N520010	TOT-M-01-03-01 Transit accessori tappi di testa	100		14
N520020	TOT-M-01-03-01 Transit accessori tappi di testa	1		14
N520021	TOT-M-01-03-01 Transit accessori tappi di testa	50		14
N525000	TOT-M-01-01-02-01 Transit soglie 68 mm TT	1		11
N525001	TOT-M-01-01-01-01 Transit soglie 58 mm TT	1		11
N625000	TOT-M-01-01-02-01 Transit soglie 68 mm TT	1		11
N625001	TOT-M-01-01-01-01 Transit soglie 58 mm TT	1		11
X				
X106000	TOT-M-01-03-02 Transit accessori	1		20
X310000	TOT-M-01-03-02 Transit accessori	1		21