

STAR 25

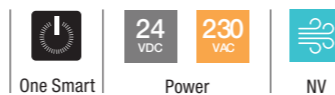

Trimmer

Posizioni 1-2-3-4-5-6: Impostazione corsa catena: 100-150-200-250-300-380 mm.

Trimmer

Posizioni 1-2-3-4-5-6: Chain stroke setting: 100-150-200-250-300-380 mm.



Vasistas
Bottom hung

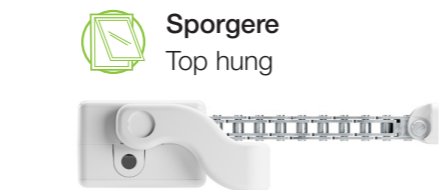

Sporgere
Top hung

Caratteristiche principali

Main features

Compatto Compact

Le dimensioni contenute consentono l'installazione anche in spazi ridotti.

The small size allows installation even in small spaces.

Sicuro Safe

I rallentamenti nelle fasi di apertura e chiusura garantiscono sicurezza e precisione.

Slowdowns in the opening and closing phases ensure safety and accuracy.

Regolabile Adjustable

6 lunghezze di corsa catena facilmente regolabili mediante trimmer anche ad attuatore non alimentato.

6 chain stroke lengths easily adjustable by trimmer even when the actuator is not powered.

Caratteristiche tecniche / Technical data sheet

	STAR 25 - 230 V	STAR 25 - 24 V
Forza Trazione / Traction force	250 N	250 N
Forza Spinta / Thrust force	250 N	250 N
Alimentazione / Power supply	110 VAC	24 VDC
Frequenza / Frequency	50/60 Hz	-
Tipo di servizio / Type of service	3 Min ON 7 Min OFF	3 Min ON 7 Min OFF
Velocità a vuoto / Unloaded stroke speed	15 mm/s	17 mm/s
Velocità evacuazione fumi / Smoke evacuation speed	No	No
Corse disponibili / Strokes available	100 - 150 - 200 - 250 - 300 - 380	100 - 150 - 200 - 250 - 300 - 380
Temperatura di funzionamento / Operating temperature	-5°C + 50°C	-5°C + 50°C
Grado di protezione IP / IP protection class	30	30
Soft START/Soft Stop	Sì / Yes	Sì / Yes
Assorbimento corrente / Current draw	0,25 A	0,8 A
Potenza assorbita / Power draw	22 W	20 W
Rilevamento ostacolo / Obstacle detection	Assorbimento di corrente Current draw	Assorbimento di corrente Current draw
Collegamento in parallelo / Connection in parallel	Max 30 Attuatori Max 30 actuators	Max 30 Attuatori Max 30 actuators
Sincronizzazione / Synchronisation	No	No
Dimensioni / Dimensions	34 X 48 X 433 mm	34 X 48 X 433 mm
Finecorsa in apertura / Open limit switch	Encoder	Encoder
Finecorsa in chiusura / Closed limit switch	Amperometrica / Amperometric	Amperometrica / Amperometric
Peso attuatore / Actuator weight	1,120 Kg	1,120 Kg

Resistente Resistance

La catena robusta a doppia maglia e a spessore maggiorato garantisce una maggiore resistenza in spinta e in trazione.

The sturdy double-link chain with increased thickness guarantees greater resistance in push and pull.

Affidabile Reliable

Le staffe di supporto consentono l'oscillazione dell'attuatore per accompagnare il movimento della finestra.

The support brackets allow the actuator to swing to accompany the movement of the window.

Finecorsa Limit Switch

Apprendimento del finecorsa in chiusura automatico per assorbimento di corrente. In questo modo è garantita una chiusura sicura e costante nel tempo.

Acquisition of the automatic closing limit switch by current absorption. In this way, a safe and constant closure over time is guaranteed.

STAR 25

Configurazione dell'attuatore Actuator configuration



Sporgere Top hung

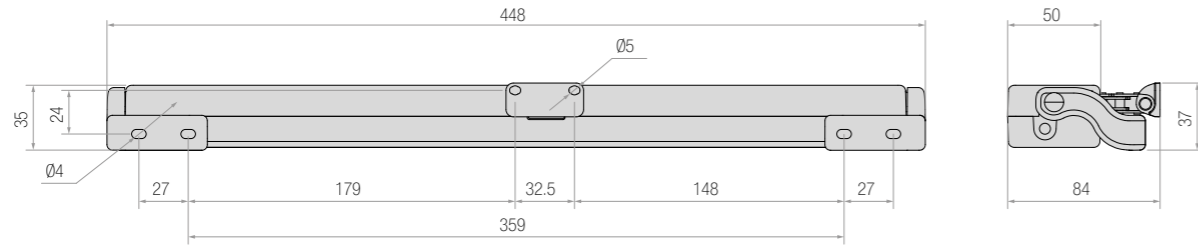

Vasistas Bottom hung

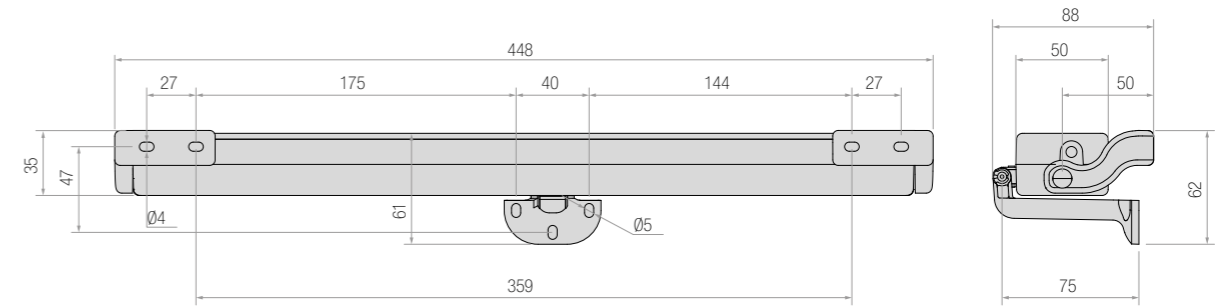

STAR 25 - Angolo di apertura anta a sporgere STAR 25 - Top hung opening angle

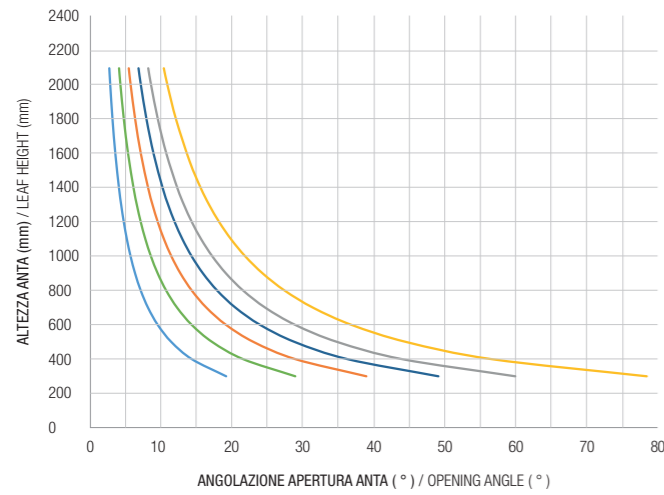

CORSA / STROKE — 100 mm — 150 mm — 200 mm — 250 mm — 300 mm — 380 mm

STAR 25 - Portate attuatori a sporgere STAR 25 - Actuator force - top hung

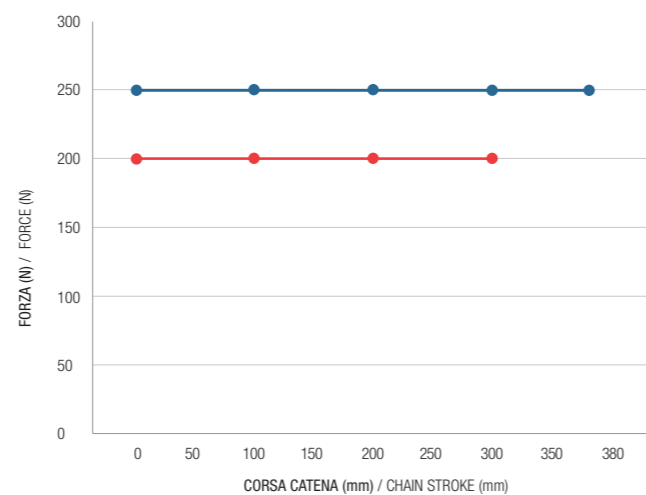

● SPORGERE / TOP HUNG OUTWARD OPENING

I valori indicati nei grafici sono da considerarsi indicativi e non considerano eventuali deformazioni dovute a fattori esterni.
The values indicated in the graphs are to be considered indicative and do not consider any deformations due to external factors.

Per scegliere l'attuatore Comunello Mowin più adatto, è necessario calcolare la FORZA (F) necessaria a sostenere il movimento della finestra. Il tipo di attuatore va selezionato considerando la combinazione tra la dimensione di BASE del serramento e la forza calcolata (N).

In order to choose the most suitable Comunello Mowin actuator, you have to calculate the necessary FORCE (F) to sustain the window movement. Choose the actuator type in accordance with the CALCULATED FORCE (N) and the FRAME DIMENSION.

STAR 25 - Angolo di apertura anta vasistas STAR 25 - Bottom hung opening angle

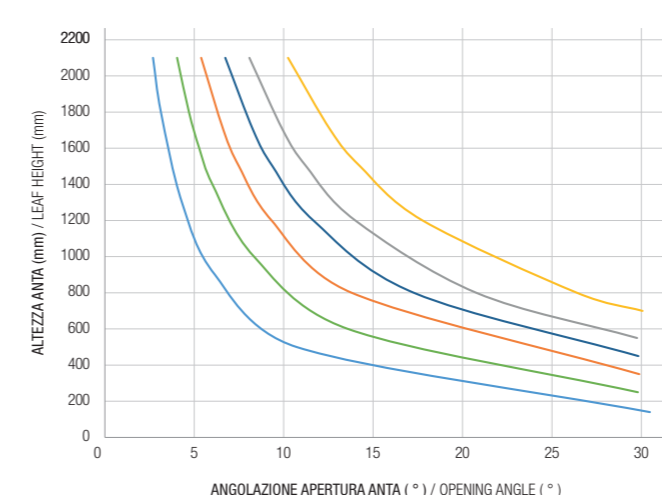

CORSA / STROKE — 100 mm — 150 mm — 200 mm — 250 mm — 300 mm — 380 mm

STAR 25 - Portate attuatori vasistas STAR 25 - Actuator force - bottom hung

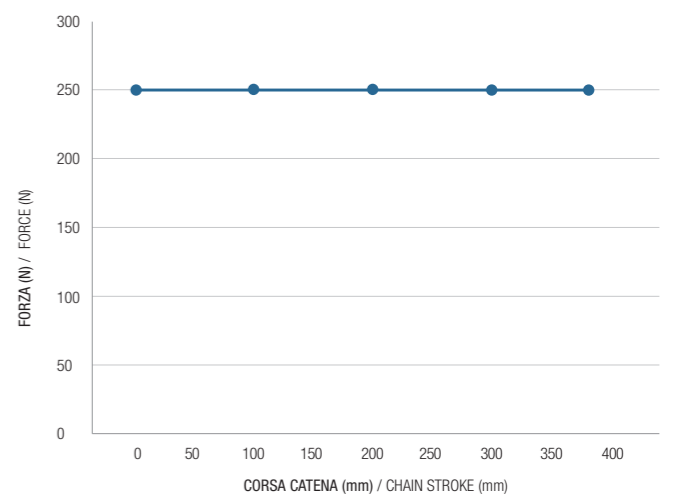

● VASISTAS / BOTTOM HUNG INWARD OPENING

I valori indicati nei grafici sono da considerarsi indicativi e non considerano eventuali deformazioni dovute a fattori esterni.
The values indicated in the graphs are to be considered indicative and do not consider any deformations due to external factors.

Formule per il calcolo della forza necessaria a movimentare il serramento Formulas for calculating the force necessary to move the window

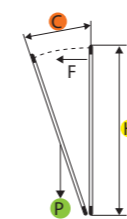

$$\frac{C \div H}{2} \times (P \div 2) = F \text{ Kg}$$

$$F \text{ (Kg)} \times 9,8 = \mathbf{N F \text{ (N)}}$$

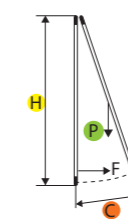

$$\frac{C \div H}{2} \times (P \div 2) = F \text{ Kg}$$

$$F \text{ (Kg)} \times 9,8 = \mathbf{N F \text{ (N)}}$$

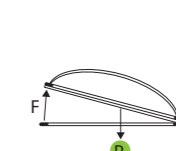

$$P \div 2 = F \text{ Kg}$$

$$F \text{ (Kg)} \times 9,8 = \mathbf{N F \text{ (N)}}$$

F = Forza necessaria
Necessary Force (Kg)

C = Corsa di apertura
Opening stroke (mm)

H = Altezza serramento
Window height (mm)

P = Peso serramento
Window weight (Kg)

STAR 25

Article	Commercial code	Product code	Push / pull	Strokes	Colour	Power supply	Weight	Pcs
STAR 25	STAR 25-24V	MT25 S VN NW 38L 0B 00 Z	250 N	100 - 150 - 200 - 250 - 300 - 380 mm	NERO / Black	24VDC	1,20 kg	1
STAR 25	STAR 25-24V	MT25 S VN NW 38L 0G 00 Z	250 N	100 - 150 - 200 - 250 - 300 - 380 mm	GRIGIO / Grey	24VDC	1,20 kg	1
STAR 25	STAR 25-24V	MT25 S VN NW 38L 0W 00 Z	250 N	100 - 150 - 200 - 250 - 300 - 380 mm	BIANCO / White	24VDC	1,20 kg	1
STAR 25	STAR 25-230V	MT25 S VN NW 38H 0B 00 Z	250 N	100 - 150 - 200 - 250 - 300 - 380 mm	NERO / Black	230VAC	1,20 kg	1
STAR 25	STAR 25-230V	MT25 S VN NW 38H 0G 00 Z	250 N	100 - 150 - 200 - 250 - 300 - 380 mm	GRIGIO / Grey	230VAC	1,20 kg	1
STAR 25	STAR 25-230V	MT25 S VN NW 38H 0W 00 Z	250 N	100 - 150 - 200 - 250 - 300 - 380 mm	BIANCO / White	230VAC	1,20 kg	1

La confezione contiene:		Box contains:				
	Attuatore <i>Actuator</i>	Staffe Vasistas <i>Vasistas brackets</i>	Staffe Sporgere <i>Sporgere brackets</i>	Staffe di supporto <i>Support brackets</i>	Dima per l'installazione <i>Mounting template</i>	Manuale d'uso <i>User manual</i>
