

Cavalieri

Per il fissaggio di piani in legno oppure lastre in appoggio su ventose o gommini.



Saddles

For wooden shelves fixing or slabs to be rested on suction or resting pad.

Da utilizzare con le serie: CTA, CMO, EDM

To use with support series: CTA, CMO, EDM

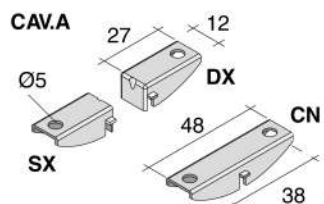

Codici Codes **Fe**
CAV.A1SX.____
CAV.A1DX.____
CAV.A2CN.____

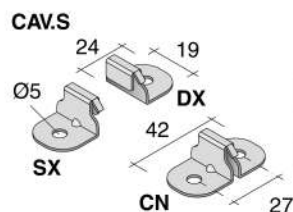

Codici Codes **Fe**
CAV.S1SX.____
CAV.S1DX.____
CAV.S2CN.____

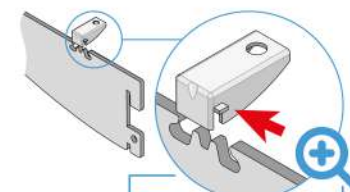

Saddle notch goes towards the wall in order to avoid shelf overturn

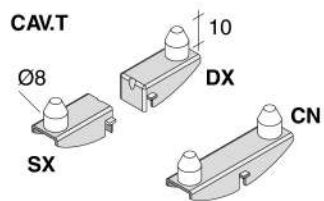

Codici Codes **Fe**
CAV.T1SX.____
CAV.T1DX.____
CAV.T2CN.____
 Per ripiani preforati
 For pre-drilled shelves

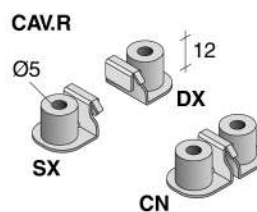

Codici Codes **Fe**
CAV.R1SX.____
CAV.R1DX.____
CAV.R2CN.____

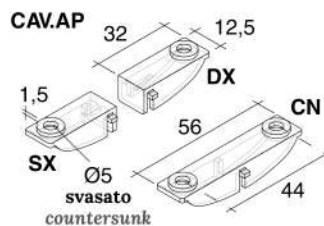
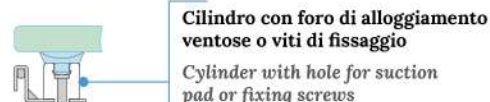

Codici Codes **Fe**
CAV.APSX.TRA
CAV.APDX.TRA
CAV.APCN.TRA
 Policarbonato stabilizzato UV
 UV stabilized polycarbonate

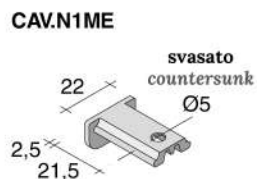

Codici Codes **Fe**
CAV.N1ME.____



Finiture Finishings	Acciaio Steel	Fe
Cromato lucido Polished chrome	CHL	
Nickel argento satinato Satinized silver-nickel	NKS	
Ottonato lucido Polished gold	OTT	*

	Fe
Nero Black	NER *
Nichelato Nickel-plated	NKL *
Nichelato opaco Matt nickel-plated	NKO *

	Fe
Zincato opaco Matt galvanized	ZIN *
Dorato opaco Matt gold	DOR *

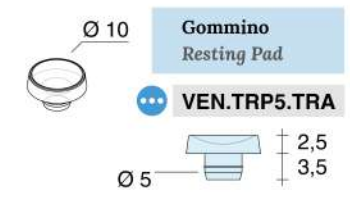

codice code
 XXX.XXXX.XXX* Asterisco = la finitura potrebbe non essere in pronta consegna.
 Asterisk = finishing not always ready in stock.

kg Capacità di carico per coppia di supporti su campata 60 cm.
 Loading capacity of 2 supports at 60 cm distance.

Quote espresse in millimetri.
 Dimensions are in millimeters.

Accessori correlati
 Related accessories

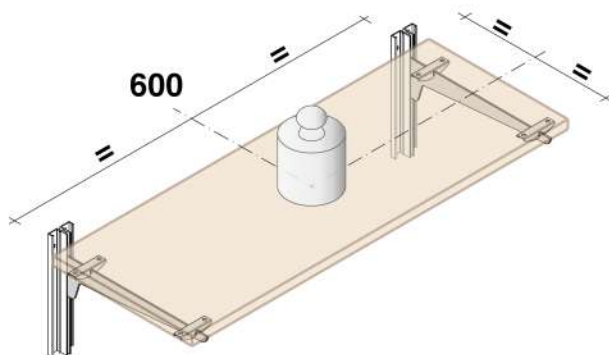

SUPPORTI CON L'USO DI CAVALIERI

I carichi fin qui richiamati riferiscono ad una coppia di supporti predisposta con cavalieri d'appoggio sulla mensola, sottoposta a controllo con il seguente metodo:

- montaggio di due cremagliere singole, perfettamente parallele, distanti fra loro 60 cm, tassellate a muro come da istruzioni;
- incastro di due supporti Fit Art nelle rispettive cremagliere ad eguale altezza;
- assemblaggio di quattro cavalieri centrali, due per ogni supporto;
- appoggio di una mensola di 70 cm sui supporti corredati di cavalieri, a sbalzo di 5 cm per lato;
- posizionamento del carico in asse alla larghezza ed alla profondità del piano (peso uniformemente distribuito a simulare applicazioni reali).

SUPPORTI SENZA L'USO DI CAVALIERI

Tutti gli altri supporti Fit Art senza cavalieri necessitano di procedura di montaggio come specificata nelle istruzioni.

I valori riportati in tabella sono pari a circa la metà dei carichi di rottura.



Per le coppie di supporti che superano il limite di 200 kg imposto durante le prove di carico dinamometriche, viene indicato il valore di 100 kg.

I valori di carico di tutti i prodotti Fit Art derivano dalla sinergia tra procedimenti industriali e forme degli articoli. La semplice riproduzione dei nostri articoli non determina gli stessi standard di robustezza perché diversi per procedimenti industriali.

SUPPORTS WITH SADDLES

The capacities indicated up to here refer to a couple of supports with saddles that undergo the following loading test:

- assembly of 2 slotted profiles, perfectly parallel, suitably fixed at 60 cm distance from each other and fixed to the wall according to the instruction;
- insertion of 2 Fit Art supports into slotted profiles at the equal height;
- assembly of 4 saddles, two for each support;
- positioning of a 70 cm length shelf on supports, equipped with saddles, with 5 cm overhang on each side
- positioning of the load centered on the shelf (the load is evenly distributed to simulate real application).

SUPPORTS WITHOUT SADDLES

All other Fit Art supports without saddles need to be assembled according to the instruction procedure.

The capacities indicated in the load chart are the half of the breaking load.



For the couple of supports that exceed the limit of 200 kg, imposed during loading test, the value 100 kg is indicated.

The loading capacities of all Fit Art products result from the synergy between the manufacturing processes and the items shapes. The slavish reproduction of our products does not determine the same standards of hardness.